

Accuphase

COMPACT DISC PLAYER

DP-55

● MMB type D/A converter achieves 20-bit linearity and minimizes noise ● Two sets of digital inputs/outputs ● Jitter-free high-performance digital demodulator ● Fully digital control of CD mechanism ● Balanced drive circuitry for servo motors



COMPACT
disc
DIGITAL AUDIO

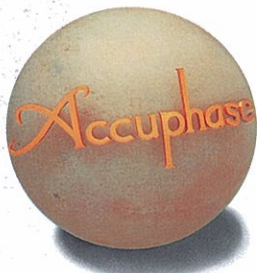

Single-enclosure CD player with ultra-precise MMB D/A converter allows independent use of high-performance processor section with superb sound. Digital inputs/outputs allow coaxial and optical connections. Fully digital control of CD mechanism achieves optimization of servo parameters in real time. Noise-free analog output with totally balanced configuration.

The DP-55 represents another breakthrough in the evolution of the integrated-type CD player. While incorporating a wealth of sophisticated Accuphase technology originally developed for top-of-the-line separate-type CD players, the DP-55 is an amazingly affordable single-enclosure model that can also serve as a digital processor.

The processor section uses the MMB principle to achieve outstanding conversion precision. Three specially selected 20-bit D/A converters are operating in parallel, resulting in excellent linearity, minimum THD, wide dynamic range, and impeccable signal-to-noise ratio. Since the DP-55 provides access to the internal converter via a set of digital inputs, its top-level sound quality and performance potential can be tapped also by external components capable of supplying a digital signal. What's more, the DP-55 also provides a set of digital outputs, allowing connection of digital recorders such as DAT or MD units, for direct digital recording of supreme quality.



Indication of external signal input

The CD transport section uses fully digital circuitry for control of all actuators and mechanical functions. This allows optimization of servo parameters for each individual disc as it is being played, resulting in stable operation and a drastic reduction of read-out errors. The laser pickup is an ultra-compact type with integrated RF amplifier, and all actuators are driven by balanced circuits which do not conduct any current to the ground line. A tray lock feature firmly secures the tray during playback, and the entire CD mechanism is mounted on a metal chassis of high rigidity, designed to minimize any vibrations that may arise during playback. In this way, the DP-55 covers every electrical as well as mechanical aspect to assure highly precise readout of the digital signal. A digital level control and balanced output circuitry are further advantages for optimum sound.

[Digital Processor Section]

MMB Type D/A Converter Yields 20-bit Linearity and Minimizes Noise

The D/A converter uses the astounding MMB (Multiple Multi-Bit) principle which delivers top-notch performance and sound quality. In the DP-55, three strictly selected 20-bit D/A converters are operating in parallel. This approach yields a dramatic improvement in every important performance aspect.

As can be seen from the illustration, the high-speed output of an 8-times oversampling digital filter is connected in parallel to the individual converters. Immediately after D/A conversion, the output of the converters is combined while still in high-speed form. Thus, rather than simply linking the converter

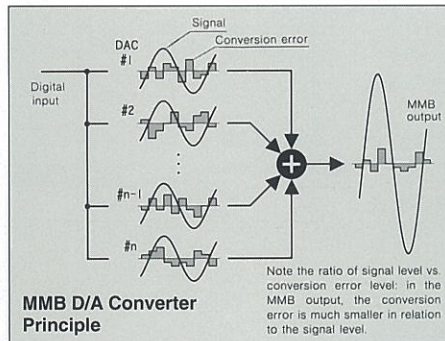

elements in parallel, the MMB circuit drives each converter separately, so that it can develop its full potential. Special attention was paid to phase response at high frequencies. Parts selection, layout and wiring patterns were optimized to achieve perfect phase matching. The end result is performance

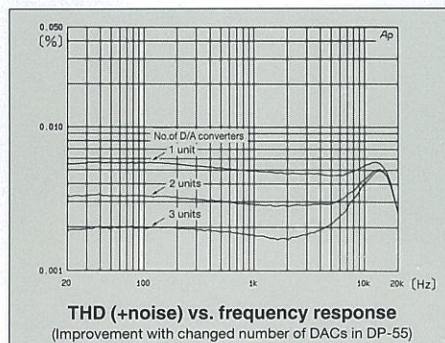

which sets new standards regarding linearity and absence of distortion and noise.

An important characteristic of the MMB principle is the fact that it improves performance regardless of signal level and frequency. The converter therefore

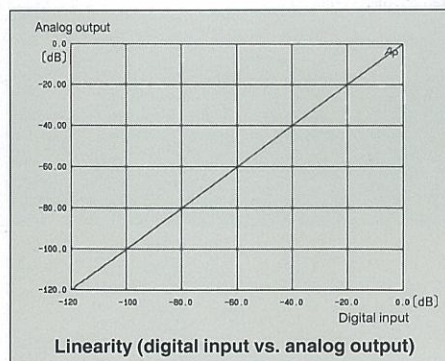

maintains excellent linearity even at extremely low levels that present insurmountable problems for conventional converter designs. The audible advantages are immediately apparent as more precise

localization of sound sources and a heightened sense of space and ambience. As illustrated by the performance chart, linearity of digital input vs analog output is maintained from the highest signal level down to levels as low as -110 dB.

Coaxial and Optical Digital Input

To allow use of the DP-55 as a high-quality digital processor, a set of digital inputs is provided for components that can supply a digital signal, such as another CD transport unit, DAT recorder, MiniDisc recorder etc. For utmost flexibility, the input can handle both optical and coaxial connections. Since internal processing of audio data is carried out entirely in 24-bit format, upgrading for future standards is also possible.



DIGITAL INPUTS

Two Digital Outputs Allow Direct Digital Recording

The DP-55 provides a coaxial and an optical output connector which let the user supply the signal in digital form to a digital recorder such as a DAT, MD, or CD-R unit. The outputs carry not only the signal from the CD, but also the signal from components connected to the digital input, allowing direct digital recording with unprecedented flexibility.



DIGITAL OUTPUTS

Jitter-Free High-Performance Digital Demodulator

Demodulation of the digital signal is carried out by a CS8412 chip (made by Crystal Semiconductor). This device not only has extremely low inherent jitter, it also is capable of absorbing any jitter components contained in the input signal. Since the chip



CS8412 digital demodulator

can handle digital signals up to a width of 24 bits, the advantages of the MMB principle can be realized with any type of program source.

20-Bit, 8-Times Oversampling Digital Filter

The purpose of a digital filter is to multiply the sampling frequency by an integer, thereby moving any spurious noise components far outside the audible range.

The filter in the DP-55 is manufactured by NPC and offers state-of-the-art characteristics in all vital aspects, such as absence of group delay, passband



20-bit digital filter

ripple, and stop band rejection. The filter approaches the theoretical limits of performance. The deemphasis stage features an IIR (Infinite Impulse Response) design to assure precise gain and phase characteristics.

4-Pole Analog Filter With Hand-Selected Components

To reduce noise in the upper frequency range and achieve high S/N ratio, a 4-pole Butterworth design is used for analog filtering. The cutoff frequency point is optimized to keep phase shifts in the passband range at an absolute minimum. Strict selection of all filter components assures sonic purity and total musical accuracy.



Remote commander RC-18

Allows operation of all functions except power on/off. Enjoy superb convenience by switching input sources or controlling features such as direct play, program play and repeat play from any location.

Digital Level Control Prevents Sound Quality Deterioration

The 20-bit MMB D/A converter in the DP-55 has a 4-bit margin, which allows precise level attenuation down to -40 dB without any loss in signal quality.

Fully Balanced Analog Output Circuitry

The audio output section features completely balanced circuitry which is isolated from the ground line. Any noise that may be induced in the signal path will be canceled out, so that the playback sound remains utterly pure and undiluted. For utmost flexibility, balanced XLR connectors as well as unbalanced RCA-type connectors are provided.



Analog outputs also accommodate balanced connections.

[CD Transport Section]

Fully Digital Control of CD Mechanism

The control circuitry of the mechanism section is fully digital, allowing the use of adaptive filters to optimize servo performance for each individual disc. This assures enhanced operation stability and a drastic reduction in error rate. Long-term reliability and performance uniformity are also improved, since fluctuations in ambient temperature can have no adverse influence.

Laser Pickup With Integrated RF Amplifier for Error-Free Operation

Since the output level of a laser pickup is very low, it is highly vulnerable to externally induced noise. To prevent such problems, the pickup used in the DP-55 employs an RF amplifier which is so compact that it can be directly integrated in the pickup assembly. This assures that the high-level output signal remains free from noise interference, which in turn reduces the error rate.

Balanced Drive Circuitry for Servo Motors

The motors and actuators which drive the disc tray, spindle, sled, and the focussing and tracking assembly require a rapidly fluctuating drive current, which can affect other circuit areas and cause sound quality degradation. In the DP-55, the drive current for each actuator is provided by two amplifiers arranged in a balanced configuration. Because there is no circuit flowing in the ground line, the

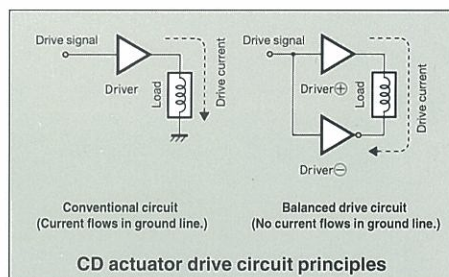

operation of other circuits in the player remains entirely unaffected.

Tray Lock Prevents Resonances

If the disc tray is disengaged from the rotating assembly while the disc is playing, resonances can

degrade the signal quality. In the DP-55, the tray is firmly secured during playback, to eliminate any possibility of harmful resonances.

Power-On Play and Frame Display

"Power-on play" means that the DP-55 can start

playback when power is turned on, allowing automatic playback in conjunction with an audio timer. For precise location of any spot on a disc, the player can display frame information (1 frame = 1/75 second), and functions such as search and repeat can be carried out in steps of individual frames.

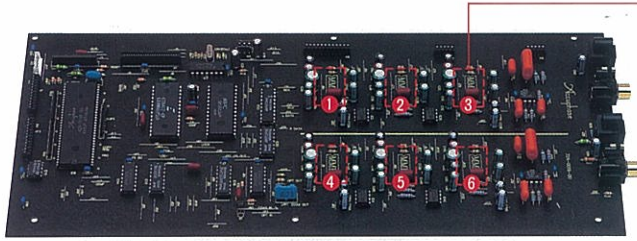

Digital circuitry and D/A converter assembly
This assembly comprises servo control ICs, digital signal processing ICs, 20-bit digital filter, MMB type D/A converter, 4-pole analog filter and other components.



20-bit D/A converters
(six units on rear side)

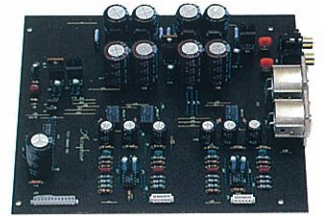

Analog output assembly
This assembly comprises the balanced audio output circuitry, power supply circuits, unbalanced output jacks, balanced output connectors and other components.

FRONT PANEL

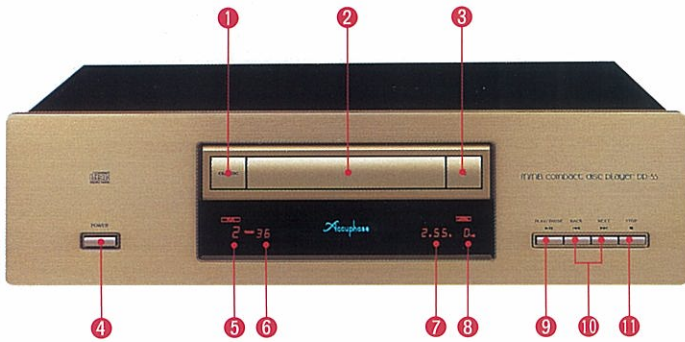

REAR PANEL

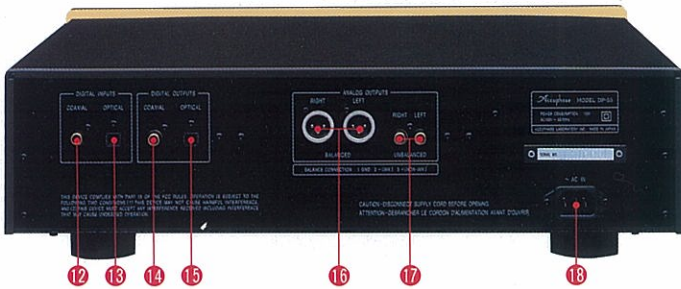

- | | |
|---|---|
| 1 CD/PROC button | 10 TRACK SEARCH button |
| 2 Disc tray | 11 STOP button |
| 3 Disc tray OPEN/CLOSE button | 12 Coaxial digital input connector |
| 4 Power switch | 13 Toslink optical fiber input connector |
| 5 Play track indicator
(Digital input indicator) | 14 Coaxial digital output connector |
| 6 TRACK/INDEX indicator
(Sampling frequency indicator) | 15 Toslink optical fiber output connector |
| 7 TIME Indicator | 16 Balanced type output connector for analog output:
(1) Ground, (2) Inverted (-),
(3) Non-inverted (+) |
| 8 LEVEL/-dB indicator | 17 Unbalanced type output jack for analog output |
| 9 PLAY/PAUSE button | 18 AC connector (for supplied power cord)* |

Remarks
*The shape of the plug of the supplied power cord depend on the voltage rating and destination country.

GUARANTEED SPECIFICATIONS

Guaranteed specifications are measured according to EIAJ standard CP-2402.

Test disc:CP-2403

Performance Guaranty

All Accuphase product specifications are guaranteed as stated.

[Digital Signal player exclusively for CDS]

- **Format:** Compact disc standard format
Number of quantizations : 16 bits
Sampling frequency : 44.1 kHz
Error correction method : CIRC
Number of channels : 2
Spindle speed : 200 to 500 rpm (CLV)
Scan velocity : 1.2 to 1.4m/s
- **Data read:** Non-contact optical pickup (semiconductor laser pickup)
- **Laser:** GaAlAs (double heterodyne diode)
- **[Digital processor]**
- **Input format:** EIA standard format
Quantization bits : 16 to 24 bits, linear
Sampling frequency (automatically selected):
32.0kHz, 44.1kHz, or 48.0kHz
- **Digital input format level:** (EIAJ CP-1201)
Format : digital audio interface
OPTICAL : Optical input, -15 to -27dBm
COAXIAL : 0.5Vp-p, 75 ohms
- **Digital output format level:** (EIAJ CP-1201)
Format : digital audio interface
OPTICAL : output -21 to -15 dBm (EIAJ)
wavelength:660nm
COAXIAL : 0.5Vp-p at 75 ohms
- **Frequency characteristics:** 4.0 to 20,000Hz ± 0.3dB
- **D/A converter:** MMB type, 20 bits
- **Digital filter:** 20 bits, Eight-time oversampling
Digital deemphasis function
Deviation : ± 0.001dB
- **Total harmonic distortion:** 0.0038% (20 to 20,000Hz)
- **Signal-to-noise ratio:** 116dB
- **Dynamic range:** 97dB
- **Channel separation:** 105dB
- **Output voltage and impedance:** Balanced : 2.5V at 50 ohms balanced XLR type
Unbalanced : 2.5V at 50 ohms RCA phono jack
- **Digital level control:** 0 to -40dB, 1 dB steps
- **Power requirements:** 100V, 120V, 220V, 230V, 240V (Voltage as indicated on rear panel) AC, 50/60 Hz
- **Power consumption:** 15W
- **Maximum dimensions:** 475mm (18-11/16") width,
140mm (5-1/2") height,
384mm (15-1/8") depth
- **Weight:** 10.8kg (23.8lbs.) net
15.8kg (34.8lbs.) in shipping carton
- **Supplied remote commander RC-18:** Remote control system : Infrared pulse
Power requirements : 3V DC
(IEC R6 batteries x 2)
Dimensions : 55mm width (2-3/16"),
194mm height (7-5/8"),
18mm depth (11/16")
Weight : 100g (including batteries)

※ Specifications and design subject to change without notice for improvements.



ACCUPHASE LABORATORY INC.

PRINTED IN JAPAN B9610Y 851-0136-00 (AD1)